

**Slovak University of Technology in Bratislava  
Institute of Information Engineering, Automation, and Mathematics**

**PROCEEDINGS**

**17<sup>th</sup> International Conference on Process Control 2009**

**Hotel Baník, Štrbské Pleso, Slovakia, June 9 – 12, 2009**

**ISBN 978-80-227-3081-5**

**<http://www.kirp.chtf.stuba.sk/pc09>**

**Editors: M. Fikar and M. Kvasnica**

Goubej, M., Škarda, R., Schlegel, M.: Input Shaping Filters for the Control of Electrical Drive with Flexible Load, Editors: Fikar, M., Kvasnica, M., In *Proceedings of the 17th International Conference on Process Control '09*, Štrbské Pleso, Slovakia, 595–601, 2009.

Full paper online: <http://www.kirp.chtf.stuba.sk/pc09/data/abstracts/064.html>

## INPUT SHAPING FILTERS FOR THE CONTROL OF ELECTRICAL DRIVE WITH FLEXIBLE LOAD

Goubej Martin \*, Skarda Radek \* and Schlegel Milos \*

\* *Department of Cybernetics, University of West Bohemia in Pilsen, Univerzitni 8, 306 14, Pilsen, Czech Republic  
fax : +420 377632502 and e-mail : cybernet@kky.zcu.cz*

**Abstract:** This paper deals with control of flexible mechanical systems. The goal is to modify the input signal in order to minimize the residual vibrations excited during a motion of a system with flexible parts. The filter is designed in the time domain via impulse function analysis. Possible application of the proposed solution is demonstrated on two examples of flexible system - control of a crane with hanging load and an electrical servo drive with attached flexible shaft. The effect of nonlinearities in the signal path caused by saturation of the servo loop controllers is studied. Various possibilities for the placement of the filter are discussed.

**Keywords:** Residual vibration control, input shaping, crane with load, flexible shaft, motion control

### 1. INTRODUCTION

The control of flexible structure systems such as cranes or robotic manipulators introduces serious problem with residual vibrations. These motion-induced oscillations are caused by the flexible parts of the system and need to be attenuated in order to obtain precise behavior of the controlled system.

Generally, there are three possible approaches to suppress the unwanted vibrations. These include mechanical damping, active feedback control, open-loop filtering methods and their various combinations. Mechanical components such as silent-blocks or spring-damper modules can be introduced into machine design in order to increase the stiffness of the construction. However, it is difficult to predict a dynamical behavior of the machine in the phase of design; moreover, mechanical dampers are difficult to tune and mean additional expenses. Closed-loop active damping methods can achieve very good results because of the feedback, which suppresses nonlinearities of the system and uncertainty in the mathematical

model (Schlegel and Vecerek (2003)), (Mertl et al. (2005)). The main disadvantage of this approach is the necessity of feedback sensors, complicated controller design and higher computational cost. On the other hand, the open-loop filtering methods use relatively simple algorithms to modify the input commands in the feed forward path in such a way that the resulting input signal led to the system does not excite the unwanted transient and residual oscillations. The advantage is simple design and absence of feedback sensors on the plant. The main drawback is the reduced robustness against uncertainty in the system model resulting from open-loop approach.

This paper deals with the last mentioned approach and uses so called Zero Vibration filter (ZV filter) (Singer and Seering (1990)) for command shaping of flexible structure systems (Huey et al. (2007)), (Chen et al. (2008)), (Sorensen and Singhose (2008)). The theory is applied to the problem of the motion control of electrical servo drive with attached crane with load or flexible shaft.

## 2. INPUT SHAPING FILTER DESIGN

A general  $n$ -pulse input shaping filter can be described in the form of impulse function:

$$IS(t) = \sum_{i=1}^n A_i \delta(t - t_i), 0 \leq t_1 < t_{i+1}, A_i \neq 0 \quad (1)$$

Where  $A_i$  means amplitude of the  $i$ -th pulse and  $\delta$  is dirac function with  $t_i$  time shift

Response of the shaper in time domain can be determined by convolution with continuous input signal:

$$\begin{aligned} v(t) &= \int_{-\infty}^{\infty} h(\tau) u(t - \tau) d\tau \\ &= \int_{-\infty}^{\infty} \left( \sum_{i=1}^n A_i \delta(\tau - t_i) \right) u(t - \tau) d\tau \quad (2) \\ &= \sum_{i=1}^n A_i w(t - t_i) \end{aligned}$$

It can be seen, that the filter has the form of sum of time delayed values of the input weighted by coefficients  $A_i$ .

The original input command is convoluted with the input shaper and the resulting signal is then led to the controlled system. This situation is illustrated in Fig. 1.

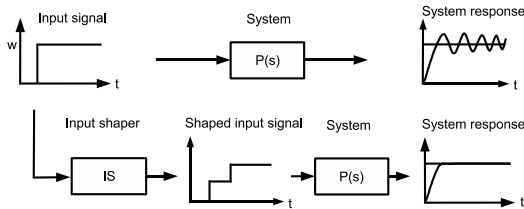

Fig. 1. Responses of the systems without and with ZV filter.

The goal of the filter design is to choose the values of amplitudes  $A_i$  and time delays  $t_i$  such that after the last pulse has been led to the system, the amplitude of excited residual vibrations is equal to zero.

The design procedure will be illustrated for 2-pulse ZV filter and second-order system.

Consider linear system described by transfer function

$$P(s) = \frac{\omega^2}{s^2 + 2\xi\omega s + \omega^2} \quad (3)$$

with impulse function

$$h_p(t) = \frac{\omega}{\sqrt{1 - \xi^2}} e^{-t\xi\omega} \sin(\omega_d t) \quad (4)$$

and two-pulse shaper with impulse function

$$IS(t) = A_1 \delta(t - t_1) + A_2 \delta(t - t_2) \quad (5)$$

The impulse response of serial connection of  $IS(s)$  and  $P(s)$  has the form

$$h(t) = A_1 h_p(t - t_1) \cdot \mathbf{1}(t - t_1) + A_2 h_p(t - t_2) \cdot \mathbf{1}(t - t_2) \quad (6)$$

where  $\mathbf{1}(t)$  is Heavids function. For time  $t > t_2$ , it holds

$$\begin{aligned} y(t) &= A_1 h_p(t - t_1) + A_2 h_p(t - t_2) \\ &= \frac{\omega}{\sqrt{1 - \xi^2}} e^{-\xi\omega t} \sqrt{C^2 + S^2} \sin(\omega_d t - \psi) \end{aligned} \quad (7)$$

where

$$\begin{aligned} C &= \sum_{i=1}^2 A_i e^{\xi\omega t_i} \cos(\omega_d t_i) \\ S &= \sum_{i=1}^2 A_i e^{\xi\omega t_i} \sin(\omega_d t_i) \quad (8) \\ \psi &= \arctan \frac{S}{C} \end{aligned}$$

It can be seen, that for minimizing the level of residual vibrations after the second pulse, the following expression has to be fulfilled

$$C^2 + S^2 = 0 \quad (9)$$

By substituting (8) to (9), we obtain a nonlinear equation for  $A_i$  and  $t_i$ ,  $i = 1, 2$ . With proper choice of values

$$t_1 = 0, t_2 = \frac{\pi}{\omega_d} \quad (10)$$

the equation can be reduced to the condition

$$\left( A_1 - A_2 e^{\xi\omega \frac{\pi}{\omega_d}} \right)^2 = 0 \quad (11)$$

Next, we get the second condition because of a requirement of the unit static gain of the filter

$$A_1 + A_2 = 1 \quad (12)$$

By solving the algebraic equations (11) and (12) we get parameters of the filter:

$$\begin{aligned} A_1 &= \frac{1}{1 + K}, A_2 = \frac{K}{1 + K} \\ K &= e^{-\frac{\xi\pi}{\sqrt{1 - \xi^2}}} \quad (13) \\ t_1 &= 0, t_2 = \frac{\pi}{\omega_d}, \omega_d = \omega \sqrt{1 - \xi^2} \end{aligned}$$

It can be shown that those values are valid also for the systems with transfer function in the form

$$P(s) = \frac{\tau s + \omega^2}{s^2 + 2\xi\omega s + \omega^2} \quad (14)$$

For the proper function of the ZV filter, the exact value of natural frequency and damping coefficient of the oscillatory part of the system has to be

known. The error in the system model results in non-zero residual oscillations. If the model of the system cannot be determined exactly, more robust version of the shaper can be designed by adding additional condition.

$$\frac{\partial}{\partial \omega} [C^2 + S^2] = 0 \quad (15)$$

The resulting three-step shaper is so called Zero Vibration Derivative (ZVD) filter and achieves less sensitivity with respect to parameter variations at the cost of slower setpoint response of the system.

### 3. CRANE WITH LOAD

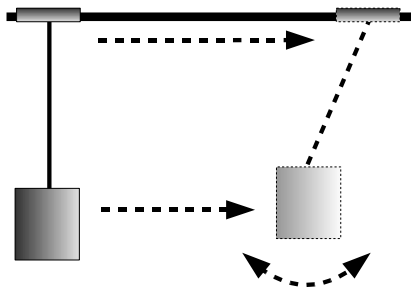

Fig. 2. Schematics of the crane and vibration of its load.

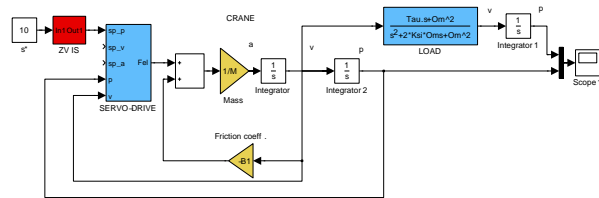

Fig. 3. Schematics of the crane with electrical drive in Simulink.

Consider an electrical driven cargo crane with hanging load (Fig. 2). Such a system is depicted in block diagram in Fig. 3. It consists of electrical part of the drive with position and velocity feedback and an oscillatory second order system described by transfer function

$$P(s) = \frac{V_l(s)}{V_c(s)} = \frac{\tau s + \omega^2}{s^2 + 2\xi\omega s + \omega^2} \quad (16)$$

where  $\omega$ ,  $\xi$  are natural frequency and damping of the system,  $V_c$  is the speed of the crane,  $V_l$  is the angular speed of the hanging load

The system (16) describes the relationship between motion of the crane and its load. The forces acting on the crane caused by the movement of the load are omitted with respect to the ratio of its mass.

The subsystem of the drive consists of three control loops in commonly used cascade structure (Fig. 4). The dynamics of the current loop is

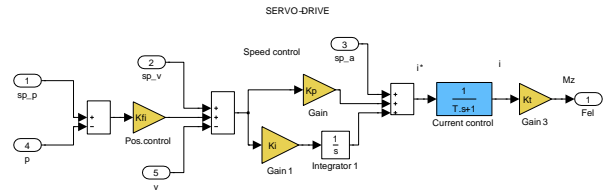

Fig. 4. Schematics of the electrical servo drive in Simulink.

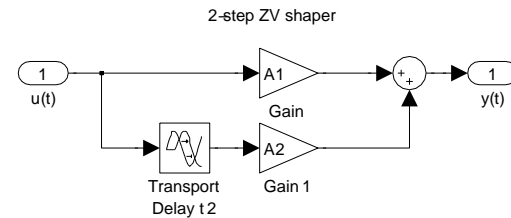

Fig. 5. Schematics of 2-step ZV filter in Simulink.

modeled as the first order system, the speed and position control is realized using standard PI and P controllers. The servo system contains also the feed forward inputs for planned trajectory following. A human operator sets the desired position of the crane  $s^*$ . Without using an input shaping filter, the motion of the crane induces the residual vibrations of the load (Fig. 6). The swinging load can hit some obstacles and an operating personnel has to wait before the oscillations damp out and they can continue with a manipulation. Using the ZV input shaper (Fig. 5), the operator command leading to the servo drive is filtered (Fig. 7) and the resulting movement does not excite the oscillatory dynamics of the load (Fig. 8).

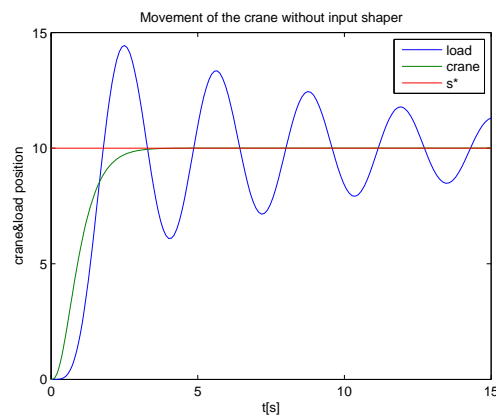

Fig. 6. Movement of the crane without ZV-filter.

The great benefit of the proposed technique is, that shaper design can be made for the second order system of the swinging load and its filtering properties stay unchanged even after passing through the dynamics of the servo drive. However, this presumption is valid only in the case, that all the control loops of the drive work in the linear mode. If any of the controllers hits the saturation limits, the original filtered command signal

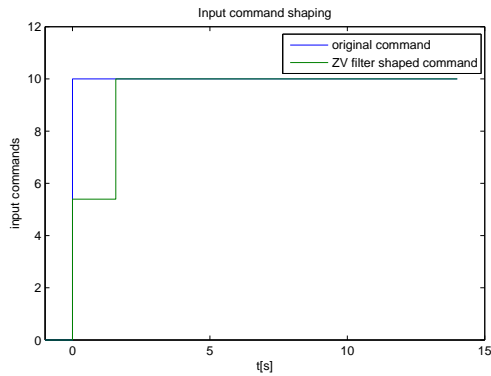

Fig. 7. Comparison of the original and shaped command signal.

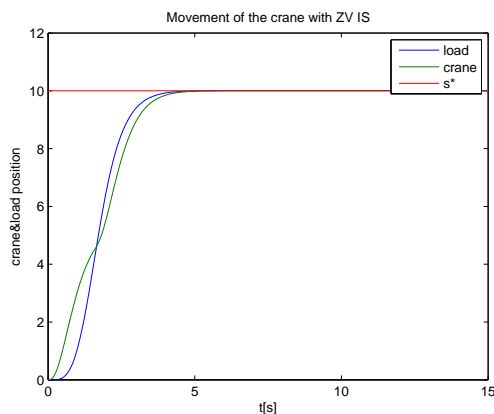

Fig. 8. Movement of the crane with ZV-filter.

is corrupted and the result is non-zero amplitude of the excited residual vibrations. This situation is depicted in Fig. 9, where saturation has been placed to the current control loop. It can be seen, that the vibrations has not been canceled out completely due to the nonlinearity in the drive control loop.

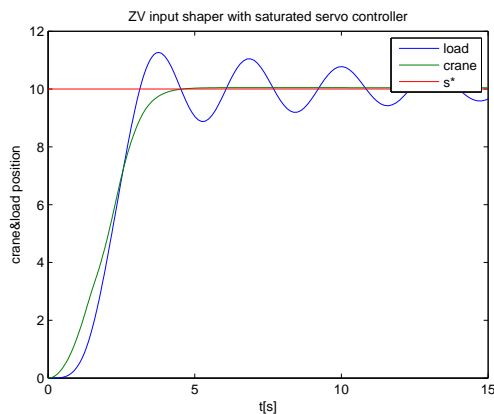

Fig. 9. Movement of the crane with ZV-filter and saturated servo controller.

A possible solution of this problem is to add an superior system for trajectory planning. After the human operator sets a new desired position, this block computes the time optimal trajectory for

the rest-to-rest movement with respect to limitations for velocity, acceleration and deceleration (optionally also with constraint for derivatives of acceleration and deceleration). The signals of desired position, velocity and acceleration led to the feed forward inputs of the servo controllers ensures the correct tracking of the planned trajectory and also prevent the saturation effect. This configuration is displayed in Fig. 10. The block AVS computes the desired trajectory, which is led to the servo drive controllers. The input shaper design remains the same, the filter has to be placed before all of the servo control inputs. Response of the system can be seen in Fig. 12. There are no residual vibrations even in the presence of nonlinearities in the servo control loop. All the controllers work in the linear mode, because of trajectory planning block. The resulting trajectory of the movement is no more time-optimal, nevertheless, it is suboptimal with respect to the demand for attenuation of swinging load vibrations. The important notice is that the filtered trajectory signal does not violate the default constraints for velocity, acceleration and deceleration due to the unity gain of the filter. Figure 11 shows the difference between t-optimal and real curves of position, velocity and acceleration. The presented example can be reduced easily to the case, where only the velocity of the crane and load should be controlled.

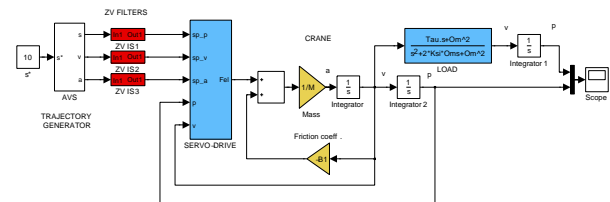

Fig. 10. Schematics of the crane with electrical drive and t-optimal trajectory generator (block AVS) in Simulink.

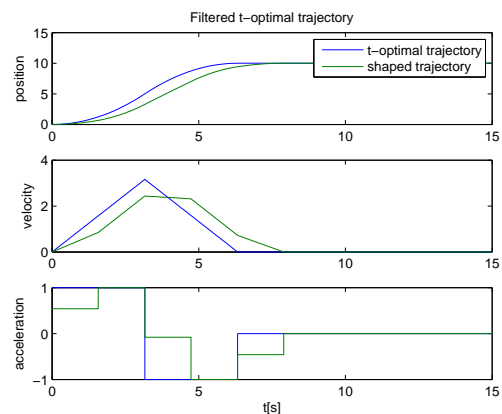

Fig. 11. T-optimal and ZV filtered trajectory for the crane.

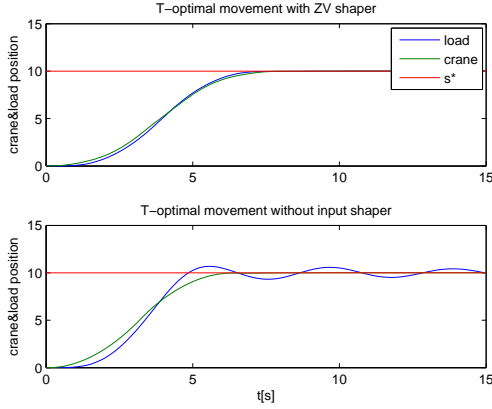

Fig. 12. Comparison of the time-optimal and time-optimal ZV filtered trajectory of crane.

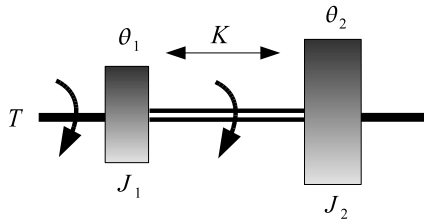

Fig. 13. Schematics of the flexible shaft.

#### 4. FLEXIBLE SHAFT

Consider a system consisting of electrical drive from the previous example and attached flexible shaft (Fig. 13). Dynamics of the system can be described by the set of two equations

$$\begin{aligned} J_1 \ddot{\theta}_1 + B_1 \dot{\theta}_1 &= T - K(\theta_1 - \theta_2) \\ J_2 \ddot{\theta}_2 + B_2 \dot{\theta}_2 &= K(\theta_1 - \theta_2) \end{aligned} \quad (17)$$

where

$J_1, J_2$  are moments of inertia of the motor and the shaft

$B_1, B_2$  are coefficients of damping

$K$  is torsion spring constant

$T$  is torque

$\theta_1, \theta_2$  are angular displacements of motor and the shaft

The goal of the control system is to control the position of the shaft without exciting the residual vibrations on the flexible end. Here, the design of the filter is not so straightforward as in the previous case. The back propagation of the torque from the end of the shaft to the drive can not be omitted analogously to the crane. The entire system including the drive and flexible feedback has to be analyzed in order to find the frequencies, which have to be attenuated.

Transfer function between setpoint command  $s^*$  and angle of the flexible end of the shaft can

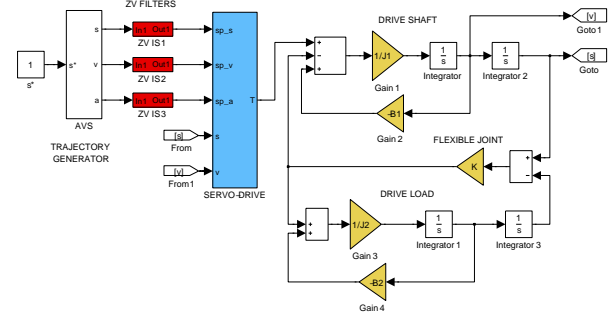

Fig. 14. Schematics of the flexible shaft with the electrical drive and ZV filter in Simulink.

be derived from the block scheme (Fig. 14). The dynamics of the current loop can be omitted, because the electrical time constant of the drive is negligible with respect to mechanical time constant of the whole system.

$$\frac{\theta_2(s)}{s^*(s)} = \frac{num(s)}{den(s)} \quad (18)$$

where

$$num(s) = KK_\theta K_t K_p \cdot s + KK_\theta K_t K_I$$

and

$$\begin{aligned} den(s) &= J_1 J_2 s^5 + (B_2 J_1 + J_2 [K_t K_p + B_1]) s^4 \\ &+ [K J_1 + B_2 (K_t K_p + B_1) \\ &+ J_2 (K_t K_I + K_\theta K_t K_p + K)] s^3 \\ &+ [K (K_t K_p + B_1) + J_2 K \theta K_t K_I \\ &+ B_2 (K_t K_I + K_\theta K_t K_p + K)] s^2 \\ &+ [K (K_t K_I + K_\theta K_t K_p + K) \\ &+ B_2 K_\theta K_t K_I - K^2] s + KK_\theta K_t K_I \end{aligned}$$

where

$K_t, K_p, K_I, K_\theta$  are parameters of controllers

$s^*$  is position setpoint

From the obtained transfer function, the location of the poles can be analyzed. For the typical configuration of the parameters, where servo control loops are set to achieve stable setpoint response without overshoot and presumption of  $J_2 > J_1$ , the resulting system has two pairs of oscillatory poles and one stable real pole. In most cases, only the slower pole pair lying closer to the imaginary axis needs to be canceled out by the filter. The natural frequency and damping can be easily computed from the location of the poles. Next, the ZV filter can be designed. If the second pair of oscillatory poles still causes unacceptable level of vibrations, a second ZV filter for faster poles can be added and serial-connected to the first one.

The problem with nonlinearities in the control loop due to saturation of servo controllers remains the same and also the solution is identical to the crane-load problem. For the proper function of the filter, trajectory planning block should be added

to satisfy the demand for the linear function of the servo loop controllers.

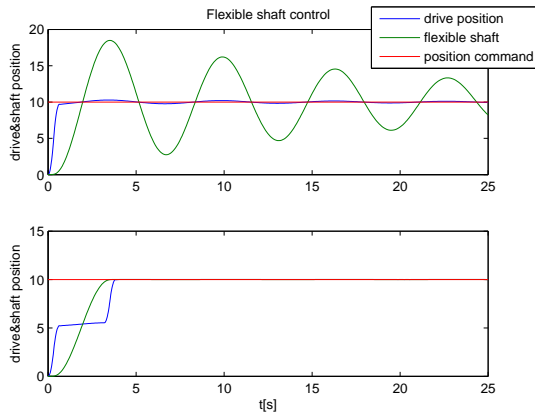

Fig. 15. Comparison of the flexible shaft movement without and with ZV filter.

Figure 15 shows the results of flexible shaft control. Figure on the top illustrates the control without the input shaper, the lower one with the ZV filter. Using the filter, the vibrations has been completely canceled out.

5. SHAPING FILTER IN THE CLOSED LOOP

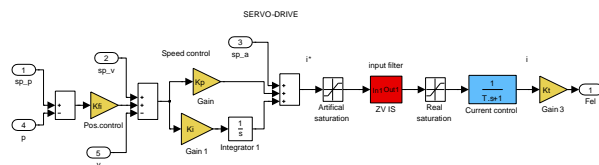

Fig. 16. Schematics of servo loop controllers with ZV filter.

The input shaping filter can be placed also in the closed loop of the servo drive. The most suitable position for the filter is the speed controller loop (Fig. 16). The advantage of this approach is, that the saturation effect of the position and speed loop does not affect the filtering properties of the shaper. For every real electrical drive, the current loop contains saturation limits due to the limited supply voltage of the power inverter. Therefore, the value of the maximal current that the inverter is able to deliver to the motor is limited. This maximal value changes with actual rotational speed of the drive because of the back electromotive-force acting against the power supply. For the proper function of the filter, an artificial saturation block should be placed before the filter (Fig. 16). The saturation limits should be chosen in such a way that the output of the filter never hits the limits of the real saturation of the current loop. This ensures that the frequency band of the signal remains unaffected and the resulting motion of the drive does not excite the vibrations of the flexible load. Next, there exist some studies indicating the

ability to suppress the measurement noise (Huey et al. (2007)) .

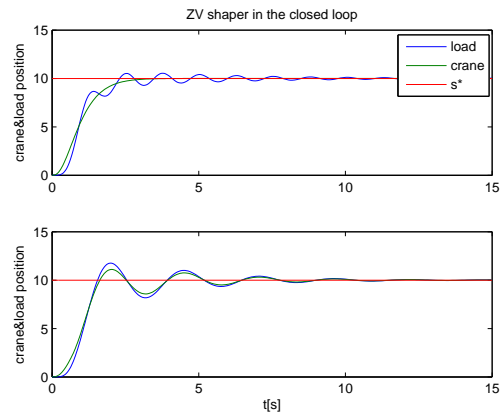

Fig. 17. System response a) without ZV filter b) with ZV filter in closed loop.

The main drawback is that the insertion of the filter introduces an additional dynamics, which can affect the behavior of the closed loop. For the large natural frequencies, which have to be attenuated, the delay of the filter can be small with respect to the dynamics of the drive. Smaller values of the natural frequency mean slower filter, which has to be taken into account while tuning the loop controllers. The effect of the filter inside the closed loop is illustrated in the (Fig. 17). The figure on the top represents the movement of the crane with load without the input shaper. The drive controllers are tuned in order to achieve fast setpoint response without position overshoot. After introducing the filter to the closed loop, the overall dynamics of the drive has changed and the result is the oscillatory movement of the crane as displayed in the lower figure. Even if the drive does not excite the residual vibrations of the hanging load, the controllers need to be re-tuned in order to achieve desired setpoint response. The integration of the filter inside the closed loop can cause even the unstable dynamics. It can be assumed that by adding an additional delay to the system, the overall dynamics of the closed loop become worse.

6. CONCLUSION

This paper presents the applications of the input shaping filters to the control of electrical servo drive with attached flexible load. The goal is to minimize any transient and residual vibrations induced by the movement of the drive. Firstly, the Zero Vibration filter is derived. The next part presents its utilization for the control of a crane with hanging load and a drive with attached flexible shaft. The results show significant improvement of the closed loop behavior and attenuation

of the unwanted oscillations. The ZV filter can be easily implemented in a real time control system and some studies show its better performance compared to conventional notch filters (Huey et al. (2007)). In the case of model uncertainty, more robust filter versions can be designed at the cost of increasing the delay of the filter. Next, the effect of saturation of the servo loop controllers is discussed and the solution is proposed by adding a trajectory planning block. The last part deals with the possibility of placing the filter inside the closed loop of the drive. The advantages and drawbacks of this approach are discussed.

*Parameters of servo drive controllers (18)*

$$K_{\varphi} = 1$$

$$K_p = 3$$

$$K_t = 1$$

$$K_I = 0.05$$

References

- K-S Chen, T-S Yang, K-S Ou, and J-F Yin. Design of command shapers for residual vibration suppression in duffing nonlinear systems. *Mechatronics*, 2008. doi: 10.1016/j.mechatronics.2008.08.005.
- J.R. Huey, K.L. Sorensen, and W.E. Singhose. Useful applications of closed-loop signal shaping controllers. *Control Engineering Practice*, 16: 836–846, 2007.
- J. Mertl, M. Schlegel, M. Cech, and P. Balda. Aktivni tlumeni vibraci lopatek v aerodynamickem tunelu . *www.rexcontrols.com*, 2005.
- M. Schlegel and O. Vecerek. Samonastavujici se regulator pro velmi slabe tlumené systémy . *www.rexcontrols.com*, 2003.
- N.C. Singer and W.P. Seering. Preshaping command inputs to reduce system vibration. *Journal of Dynamics Systems, Measurement and Control*, 112:76–82, 1990.
- K.L. Sorensen and W.E. Singhose. Command-induced vibration analysis using input shaping principles. *Automatica*, 44:2392–2397, 2008.

APPENDIX

*Parameters of crane with load model (16)*

$$\omega_n = 2 \text{ rad}$$

$$\xi = 0.05$$

$$\tau = 0.05 \text{ s}$$

$$M = 1 \text{ kg}$$

*Parameters of flexible shaft model (17)*

$$J_1 = 1 \text{ kg} \cdot \text{m}^2$$

$$J_2 = 10 \text{ kg} \cdot \text{m}^2$$

$$K = 0.1$$

$$B_1, B_2 = 0.1$$